

DIVESOFT

Freedom

USER MANUAL

Advanced Bottom Timer

CCR Bottom Timer



HW rev. 3.0, FW 1.12

August 2015

Divesoft Freedom User Manual

Advanced Bottom Timer

CCR Bottom Timer

Author

H c a ½ ´ G ` ½ X Y _

Publisher

Divesoft s.r.o.

www.divesoft.cz

Issue

Version 1.00

24. August 2015

Use of this manual approved by

@i W] Y ´ a Y ^ _ U ` c j ½ž ´ 7 9 C

Introduction

Use of this manual

This user manual is part of the Divesoft Freedom documentation.

The Divesoft Freedom is intended for use exclusively by a trained person who is capable of fully understanding the instructions contained in this manual.

The technical documentation is subjected to a process of continual development and improvement. Therefore, please regularly check the website at www divesoft.cz for updates.

This manual provides operating instructions for the hardware and software (firmware) version of the Divesoft Freedom written on the title page.

Safety

Warning: The bottom timer is not a decompression computer. Use appropriate methods for the decompression profile and oxygen exposure calculations.

Warning: Use backup instruments! Ensure that you have access to backup instruments for measuring depth and time. Never risk your life by relying only on one source of information.

Warning: Always check the device before diving in order to ensure that the display works, the device has not run out of battery power and all settings are correct.

Warning: All software contains bugs and the firmware of the Divesoft Freedom is no exception. The computer can never blindly be trusted.

Warning: This computer may malfunction at any time. The question is not whether it will fail but when it will fail. Always have a plan on how to handle failures.

Responsibility of the Divesoft Freedom user

A Divesoft Freedom user must accept the fact that diving involves risk. Following everything that the user has learned in the [8 \] j Y g c Z h](#) : [technical documentation](#) and in training can reduce the risk but cannot eliminate it. Safety when diving is further enhanced by regular training, methodical education and good diving practices. Technical diving requires a far higher degree of care and discipline than recreational diving.

If you do not accept the risk and you are not a trained, careful and disciplined diver, do not dive with the Divesoft Freedom.

Upgradable computer

The hardware of all versions of the Divesoft Freedom computer is the same ¹. Only the software differs. The software version can be upgraded.

A logical upgrade for the Freedom Advanced Bottom Timer is the CCR Bottom Timer . The software version can also be upgraded to the Full Trimix or Closed Circuit version of the Divesoft Freedom decompression computer.

¹ The Closed Circuit version includes a cable for connection to a rebreather  g Y b g c f g

Contents

Section 1: Quick start guide	6	6.1.2 Orientation [Left hand]	23
Section 2: Operation	7	6.1.3 Alarms	23
2.1 Control elements	7	6.1.4 Preferences	26
2.1.1 Meanings of inputs in surface modes	7	6.1.5 Calibration	27
2.1.2 Meanings of inputs in dive modes	8	6.1.6 Date and time	28
2.1.3 Language	8	6.1.7 Factory defaults	28
2.2 Switching on the unit	9	Section 7: Rebreather	29
2.3 Switching off the unit	9	7.1 Surface menu	29
2.4 Brightness control	10	7.1.1 Stack time reset	29
2.4.1 Advised strategies for diving in darkness ..	10	7.1.2 G h U f h ' C ' [W.U.] . V.f. U h] c..b29	
Section 3: Surface	11	7.1.3 7 \ U b [Y ' .C.....W.U.]	29
3.1 Surface mode	11	7.2 Setup	30
3.1.1 Entering surface mode	11	Section 8: System check	31
3.1.2 Surface mode screen	11	8.1.1 Version	31
3.1.3 Switching to other modes	12	8.1.2 License	31
Section 4: Dive	13	8.1.3 Battery	31
4.1 Bottom timer	13	8.1.4 Pressure sensors status	31
4.1.1 Synoptic screen	13	Section 9: Games	32
4.1.2 Big Screen	14	9.1 Sokoban	32
4.1.3 Dive profile screen	15	9.2 Snake	32
4.1.4 Dive menu	16	Section 10: Service functions	33
4.2 CCR Bottom Timer	18	10.1.1 Debug	33
4.2.1 C ' g Y b g c f g [W.c..b..Y..Wh] c18		10.1.2 Test	33
4.2.2 Synoptic screen	18	10.1.3 Demo dive	34
4.2.3 Big Screen	19	10.1.4 Syslog	34
4.2.4 Dive profile screen	19	10.1.5 Miscellaneous	34
4.2.5 Sensor screen	19	Section 11: Hardware	36
4.2.6 Dive menu	19	11.1 Charging	36
Section 5: Log book	20	11.2 Wrist mount	36
5.1 Last dive	20	11.3 Physical dimensions	37
5.2 Dive list	20	11.4 C ' g Y b g c .f.W.U.V. . Y ..	38
5.3 Summary	21	11.5 Environmental specifications	39
5.4 Log download	21	11.6 Compliance	39
5.4.1 Log processing in the cloud	21	11.6.1 CE marking	39
5.4.2 Off-line log processing	21	11.6.2 EN 13319	39
Section 6: Setup	22	11.7 Disposal of waste equipment	40
6.1.1 Brightness [7]	22		

Section 1: Quick start guide

1. Recharge battery

Use the charger included in the package or another suitable USB charger or a computer USB port. See [Charging](#) (page 36) for detailed information.

2. Switch on

Hold both buttons until you feel a vibration and the display starts. The computer will be in surface mode after a few seconds.

3. Reset to factory defaults if necessary

It is not necessary to reset a new computer. If you are in doubt about the correct setting, perform the reset to factory default.

Short press both buttons to enter the menu. Move the cursor to Setup with the lower button and select with the upper button. Then move the cursor to Factory defaults, select and confirm. Horizontal calibration starts automatically after the reset. Place the computer on a table and press any key.

4. Adjust to right hand if required

Adjust display orientation to your preference. Short press both buttons to enter the menu. Move the cursor to Setup with the lower button and select with the upper button. Then select the Orientation menu item.

5. Switch to imperial units if required

Adjust the units to your preference. Short press both buttons to enter the menu. Move the cursor to Setup with the lower button and select with the upper button. Then select Preferences Units.

6. Select wrist mount

If you prefer a strap, attach the strap to the computer. If you prefer a bungee, then remove the screws holding the bars and pass the bungee through the threaded holes.

See [Wrist mount](#) (page 36) for detailed information.

7. Plan your dive

Use appropriate methods for the decompression profile and O₂ exposure calculations.

8. Switch to dive mode

In the menu select Dive or enter the water and submerge to a depth greater than 1.5 m.

Now your Divesoft Freedom Bottom timer is prepared for a dive.

Section 2: Operation

2.1 Control elements

The following inputs and combinations are differentiated:

- < Press upper key
- < Press lower key
- < Press both keys
- < Long press upper key
- < Long press lower key
- < Long press both keys
- < Coded key press (press both keys, then release one key and press it again, then release both keys)
- < Tilt away from yourself
- < Tilt toward yourself
- < Tilt to the left
- < Tilt to the right
- < Tap the display glass
- < Shine a light on the display

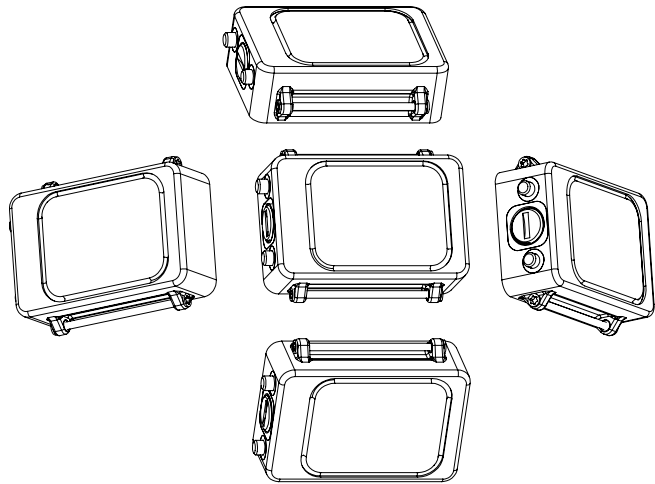

is terminated at the moment the key is released or, in case of pressing both keys, when the last key is released.

The upper/lower keys and directions of tilting are determined by the display orientation, depending on whether it is set up for the left or right hand.

2.1.1 Meanings of inputs in surface modes

The keys and other inputs are assigned meanings in connection with the current navigation item in the menu. At the same time, however, general rules, which apply wherever possible, are determined for their use.

- Press upper key confirm the menu item just selected
- Press lower key cycle downward through the menu
- Press both keys exit the menu without performing any action
- Long press upper key page up
- Long press lower key page down

Long press both keys return to main screen

Coded key press enter service functions menu

Tilt away from yourself increase of the entered digit by one or check flag

Tilt toward yourself decrease of the entered digit by one or uncheck flag

Tilt to the left move the cursor to the left

Tilt to the right move the cursor to the right

Wherever possible (menu, editing screen), helpful symbols relating to the keys are displayed. A symbol can be either next to a key, indicating the action executed during a short key press, or between the keys, indicating the action executed during a short press of both keys.

The  symbol next to a key means move down one row in the menu. Moving in the menu is cyclical, so the first row appears again after the last row. The move-up function is not available.

The  symbol means return one level without executing any action.

The  symbol represents confirmation of the action or selection.

2.1.2 Meanings of inputs in dive modes

The meanings of inputs are the same as in surface modes. Other possibilities are:

Tilting is expanded with movement in games; otherwise, entry of digits, for which tilting is used in surface modes, is limited during the dive to only special cases.

Tapping on the display glass switch on the display if it is switched off.

Shining a light on the display in the dark, illuminating the display with a dive light activates it similarly as when tapping on the glass. In the light, the display can be activated by covering and then uncovering it.

2.1.3 Language

All textual information on the Divesoft Freedom is in English. Controlling the apparatus requires knowledge of the English language at a level that, at least, allows the user to thoroughly understand this information.

2.2 Switching on the unit

The device is switched on by pressing both keys for three seconds.

Automatic activation occurs in the event of entering the water in standby mode. If submerged to a depth greater than 1.5 m, the computer switches on.

Automatic activation is not immediate, it is necessary to wait a few seconds. The computer may be switched on automatically in higher depth while rapidly descending. Then the first few seconds of the dive profile record will be lost.

The automatic activation on submersion is disabled when switched to the flight mode.

In case the diver forgets to switch on the computer after a flight, the computer will switch on at 5 m depth within 1 minute.

2.3 Switching off the unit

Enter the menu from surface mode, select Switch off and select Switch off again in the second menu as a confirmation. The computer will be switched off to standby mode.

Or you can select Switch off in the first menu and select Flight mode in the second menu. This prevents automatic activation due to rapid pressure change and confusion of the surface level detection algorithm (e.g. during an aircraft landing).

You can switch off directly from dive mode while on the surface. This way the unit will be switched to standby mode, so automatic activation by submersion is enabled.

The other way to switch off is by waiting for a timeout.

Upon surfacing the Freedom will switch to surface mode after the time set in the dive termination timeout. Then it will switch to standby mode after the time set in the surface idle timeout. Pushing any button restarts the idle timer in surface mode.

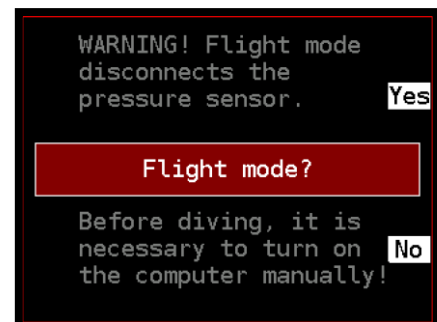
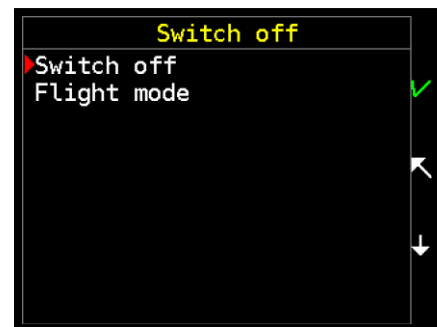

2.4 Brightness control

The levels of the display backlight brightness can be changed using the lower key. The display can be switched off, can be switched to preset and to maximum brightness. The level of the preset brightness can be set in Setup Brightness.

If the display is off, then use the short press to switch it on. After switching it on, pressing with a short delay between presses (< 1 s) switches the brightness level.

The display brightness can be changed by pressing the lower key repeatedly. If it is necessary to switch to maximum brightness just short press the lower key repeatedly. The maximum brightness will be set after two button pushes (if the display was off in the beginning) or three pushes (if the display was on).

2.4.1 Advised strategies for diving in darkness

High brightness all the time

This is the preferred option for a simple dive with a high power diving light (torch) used by all team members. Brightness level 6 to 8 is recommended.

When diving in the peripheral vision, otherwise it may lead to the separation of the team members.

Switching on -off

This option is typical for cave diving. Set brightness to a high level (6 to 9) and a short screensaver timeout (15 s is more than enough).

Preferably activate the display by light during a dive. Move the Freedom to the light beam instead of moving the beam to prevent confusion with a light signal.

Low brightness

For diving with eyes accommodated to darkness use the lowest brightness setting (level 1). Your night vision will not be disturbed. It is preferred to have the display on all the time (i.e. screensaver timeout set to 0). This option is typical for dives in clear water.

Dive with slightly brighter display while using a low power torch. Balance the power of the backlight to the power of your torch to find the optimal setting – no glare but good legibility.

To switch to maximal brightness just short press the lower key repeatedly.

Section 3: Surface

3.1 Surface mode

The surface mode is indicated by the gray table gridlines.

3.1.1 Entering surface mode

The Divesoft Freedom switches to surface mode upon being switched on.

3.1.2 Surface mode screen

Date and Time

Maintain a correct local time setting. It will be used for log recording.

Surface time

This shows the time from a previous dive. If it was 99 days ago or more, then the FREEDOM banner appears instead of the time.

Battery symbol

A graphical indication shows the remaining battery capacity. The estimated capacity of a full battery is about 10 hours.



The battery is full



More than half capacity



Less than half, but more than quarter capacity



Less than quarter capacity



Charging is in progress



The battery is full, but plugged into a charger

For detailed information, see the battery screen in the system check.

3.1.3 Switching to other modes

The user can switch from surface mode to dive mode in the menu.

The Freedom computer can also be switched to the service menu. See chapter Service functions (page 33).

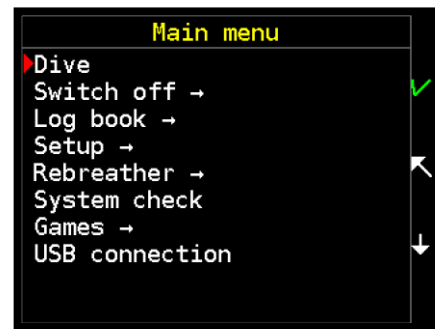

Section 4: Dive

4.1 Bottom timer

The Advanced Bottom Timer dive mode is identical to the CCR Bottom Timer dive mode without the connected O₂ sensors.

4.1.1 Synoptic screen

Stopwatch

Operate the stopwatch via the menu. See [Stopwatch](#) (page 16).

Battery symbol

A graphical indication shows the remaining battery capacity. See chapter [Surface mode - Battery symbol](#) (page 11).

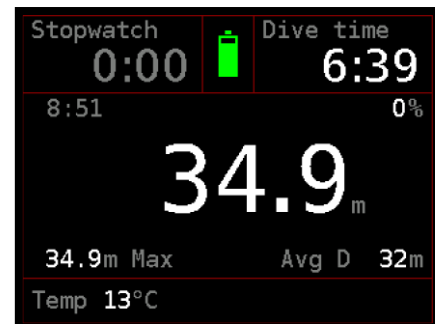

The Divesoft Freedom can not be powered externally and re-charged during a dive (e.g. in hyperbaric chamber or in diving bell) without a special setting which is available only on request.

Dive time

The timer starts after submersion (depth > 1.5 m) and halts after surfacing (depth < 0.5 m). If stay on the surface (or at very shallow depth) is followed by a second submersion (during a time set in the dive termination timeout) , then the dive time indicated will be the time from the first submersion including the surface time.

Local Time

The local time is shown on the display in the top left corner of the middle section.

Vertical speed

The ascent and descent rate indication can be set to a relative (%) or absolute (m/min or ft/min) reading. The relative reading is based on the maximum ascent or descent rate. Set in Setup Preferences and Setup Alarms Rate Rate setup.

Depth

The depth reading can be set to m or ft in the setup. Depth is calculated from measured hydrostatic pressure. For calculation fresh water (default) or seawater density can be set in Setup Preferences.

Max Depth

The maximum depth reached during the dive .

Avg depth

The average depth of the dive. A new start point for depth averaging can be created via the dive menu. This point is indicated by the yellow vertical line on the profile screen.

Temp

Water temperature is measured inside the computer case. After a temperature change wait about 1-2 minutes until the temperature reading reaches a stable value . The temperature in air is affected by many factors and is only an indication.

A temperature correction can be set in Setup Calibration for better accuracy.

4.1.2 Big Screen

The most important information is written in really big characters.

This screen is useful in very bad visibility. Many divers can read the numbers even without a mask .

The meaning of all values is identical to the detailed screen.



Dive time	6:50
Depth m	34.9
Avg depth m	31.7

4.1.3 Dive profile screen

Start

The time of submersion is useful for checking compliance with the schedule.

Avg

The average depth is indicated in yellow by a horizontal line and a numerical value .

A new start point for depth averaging can be created in the dive menu . This point is indicated by the yellow vertical line and the horizontal average depth line starts from there.

Current depth

See lower left corner.

Dive time

The runtime of the current dive is placed in lower right corner.

Max

The maximum depth reached during the dive. The field with this value is placed in the middle of bottom line.

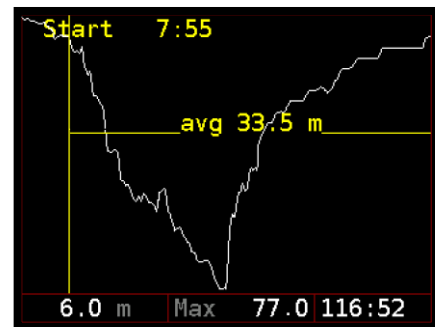
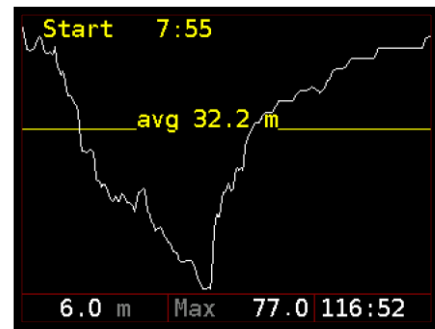

4.1.4 Dive menu

During a dive, in any dive mode, press both keys simultaneously to show the dive menu.

This shows current depth, partial pressure of oxygen (rebreather only) and dive time on the bottom of the screen.

Stopwatch

The elapsed time is written in white while the stopwatch is running or in gray when the stopwatch is not running .

Start stopwatch

This starts the timer.

If the stopwatch was previously halted then the count continues from the indicated time.

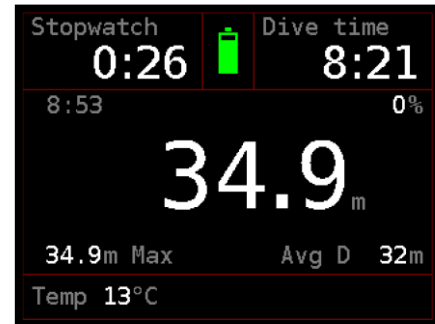

Stop stopwatch

This stops the timer, leaving the elapsed time displayed .

Clear stopwatch

This completely resets the stopwatch to zero.

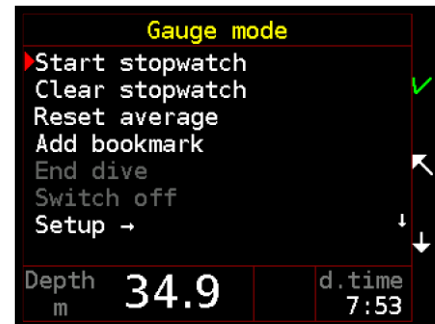

Restart stopwatch

This restarts the timer from zero.

This function is especially useful for decompression stops.

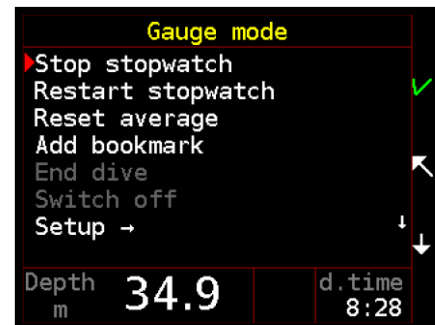

Reset average

A new start point for depth averaging will be created. The restart point is indicated by the vertical line on the dive profile screen.

Add bookmark

A bookmark will be created in the dive log. The bookmark number is displayed in the notification that follows.

End dive

End dive and switch to surface mode. This menu item is enabled only on the surface.

Switch off

End dive and switch directly to standby mode. This menu item is enabled only on the surface.

Setup

Brightness

The display backlight brightness level can be set from 1 to 9. The change in brightness is immediately reflected while adjusting.

Orientation

The left hand, right hand and auto orientation can be selected.

Auto orientation selects the left or right hand position automatically during the start. It will not switch the display orientation when the diver changes position (i.e. during a head down descent).

Screens

Any of the dive mode screen can be disabled.

Games

You can pass the time on a decompression stop with playing games.

See [Games](#) (page 32).

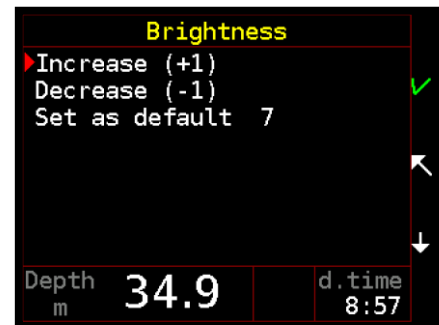

4.2 CCR Bottom Timer

The rebreather dive mode is only available in the CCR Bottom Timer version with at least one connected O₂ sensor.

It is strongly recommended to familiarize yourself with basic bottom timer functions before use with a rebreather. This chapter of the user manual describes only additional functions.

4.2.1 O₂ sensors connection

The CCR dive mode requires a connection to the O₂ sensors of a rebreather. One, two or three sensors can be connected.

The cable equipped with the Molex connectors is included in the Closed Circuit version of the Divesoft Freedom distribution package or can be ordered separately. See also chapter O₂ sensor cable (page 38).



4.2.2 Synoptic screen

O₂ sensor

The pO₂ values measured by two or three individual O₂ sensors are located in the center of bottom section.

Reading in red characters indicates a sensor in non-calibrated state; gray --- indicates a sensor in error state.

This field remains empty if only one sensor is connected.

pO₂ reading

The arithmetic average of two or three active O₂ sensors or the pO₂ reading from a single sensor is shown in the bottom right corner of screen.

The number of sensors is set in Setup Rebreather.

You can mark any sensor as faulty during a dive. In dive menu select G Y h i d : U i h m sensors.

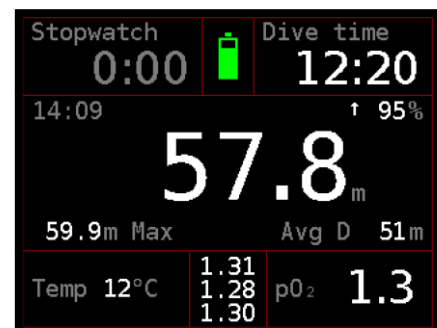

4.2.3 Big Screen

The most important information is written in really big characters.

The meaning of all values is identical to the detailed screen.



4.2.4 Dive profile screen

This screen is identical to the bottom timer without C sensors.

4.2.5 Sensor screen

C sensors

There is a separate O sensor screen in both the surface and dive mode.

Not only the pC but also the voltage on sensors can be read. If the state of a sensor is not in operational mode (not connected, error, excluded, disabled, uncalibrated), the appropriate tag appears instead of the pC value.

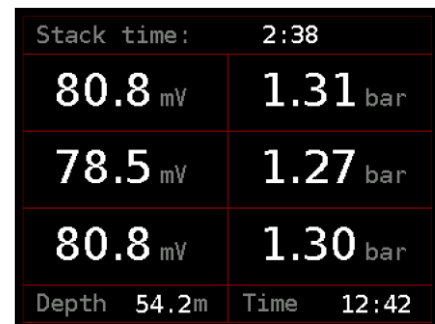

Stack time

The scrubber stack timer runs all the time in dive mode regardless of depth, even on the surface.

= Z i m c i i g d Y b X i U i c b [i h] a Y i] b i X] j Y i a c X Y i k \] i Y i b c h i V f Y U h then increase the time for the stack time warning.

Don't forget to reset the timer when you refill the scrubber (Rebreather Stack time reset).

4.2.6 Dive menu

Faulty sensors

You can mark any sensor as faulty during a dive.

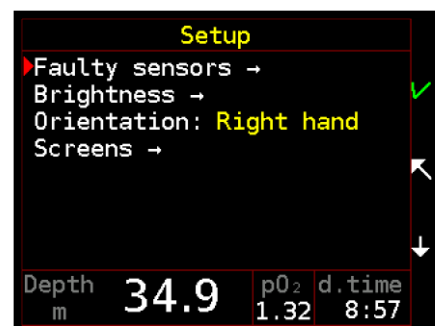

Section 5: Log book

5.1 Last dive

Details from the last dive from list.

Dive profile

The graph is plotted with a white line.

Date and time

The time of submersion.

Depth

The maximum depth of the dive.

Duration

This indicates time from submersion at the start of the dive to surfacing at the end of the dive. It includes all surface stays, if they were part of the dive.

Avg depth

The average depth, calculated from the whole profile.

Min temp

The temperature at its coldest point during the dive (measured during the ascent).

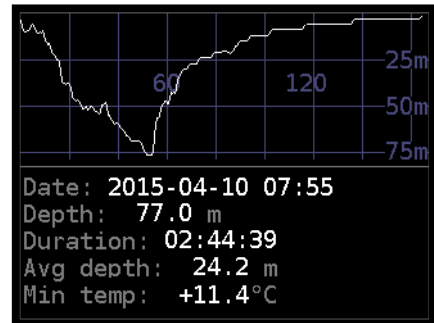

5.2 Dive list

Here all dives from the memory of the Divesoft Freedom are listed. The memory capacity is approximately 100 hours of typical dive profiles. When the memory is full, the oldest records are automatically deleted.

Second and subsequent dives in one day are marked with corresponding letters.

Demo dives (logs stored after the dive simulation) are marked with light blue characters.

Test dives are marked with red characters (e.g. the first dive to approx. 350 m).

Use upper button short press to open the screen with the dive details.

Use long press to go through the pages.

Dive	[min]	[m]
2015-05-17 c	10:22	27.1
2015-05-17 b	41:27	53.2
2015-05-17	31:44	18.8
2015-05-16	71:45	50.2
2015-05-05 c	42:28	32.0
2015-05-05 b	42:01	39.7
2015-05-05	44:01	39.1

Hold to next page

5.3 Summary

A summary of all dives from the memory of the Divesoft Freedom is shown (test and demo dives excluded).

5.4 Log download

Connect the USB cable included in distribution package to the USB port of your computer, tablet or mobile phone. A USB adapter will probably be necessary for mobile devices.

Select the USB connection item in the menu. The Divesoft Freedom memory can be connected as a mass storage device (like a flash drive). The connection to Windows, Mac, Linux, Android and iOS was tested, but there is no guarantee of compatibility with all operating systems and all computers. Access to the internal memory is read only.

Logs are stored in the DIVELOG folder; data from one dive is stored as one *.DLF file.

5.4.1 Log processing in the cloud

Download files from the DIVELOG folder to your hard drive and then upload data to WETNOTES.COM. Here you can store and edit your dives, study graphs, details and much more. If you wish, you can share dives with your buddy or a group.

Visit WETNOTES.COM and explore all the possibilities that it has to offer!



5.4.2 Off-line log processing

A simple desktop application for reading dive logs directly on a PC with MS Windows can be downloaded at

www.divesoft.cz/support.

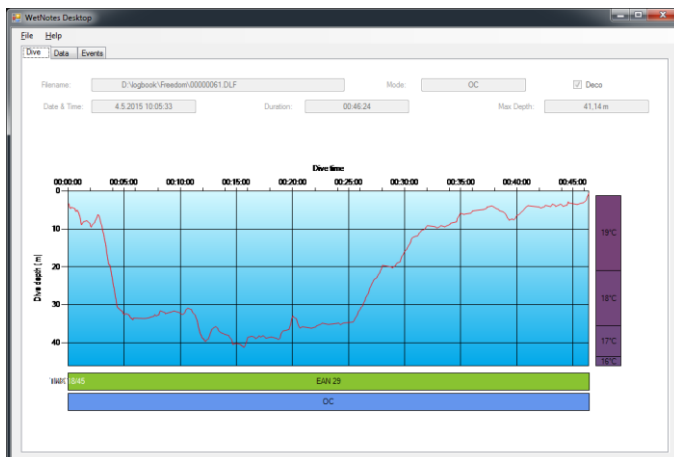
A screenshot of the WetNotes Desktop application showing a table of dive data. The table has columns for "When", "Depth", "ppO2", "NoDeco", "Ascent", "Temp", "Ceiling", and "Seppart". The data rows show various dive parameters for different times during the dive, such as depth, partial pressure of oxygen, no-decompression status, ascent rate, temperature, ceiling, and seppart.

Section 6: Setup

The Divesoft Freedom Advanced Bottom Timer is configured in the surface mode. Activate the surface mode main menu with a short press of both keys and select Setup.

If you are not sure which value to set, leave the values of the default setting.

The factory default setting value is shown in square brackets in the following headlines .

6.1.1 Brightness [7]

The display backlight brightness level can be set from 1 to 9. The change in brightness is immediately reflected while adjusting , so it is preferable to change this setting in the shade or in the dark .

For diving with eyes accommodated to darkness use the lowest brightness setting (level 1). Use high brightness (level 7 to 9) for diving with a high level of ambient light.

Also see [Brightness control](#) (page 10).

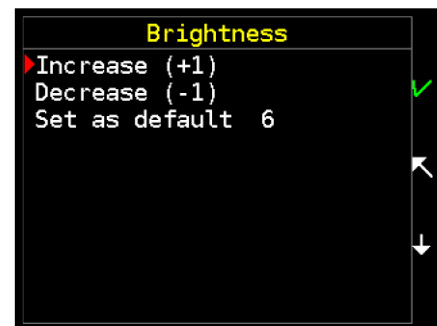
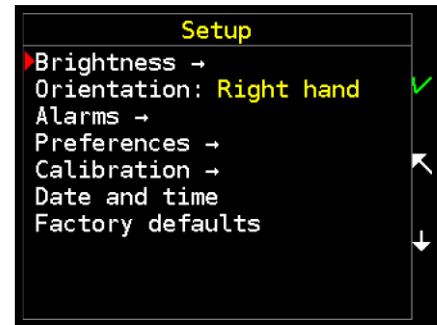

6.1.2 Orientation [Left hand]



The left hand, right hand and auto orientation can be selected.

Auto orientation selects the left or right hand position automatically during the start. It will not switch the display orientation when the diver changes position (i.e. during a head down descent).

6.1.3 Alarms

The Divesoft Freedom uses vibrating alarms. Users can even feel the vibration through a drysuit. There are no audible alarms.

All alarms and notifications can be switched on or off. If you do not have any serious reason to deactivate the alarms, leave them switched on.

Rate Ascent rate [On]

An ascent speed exceeding the permitted value for the current deep interval activates this alarm.

See ascent rate setting in Setup Alarms → F U h Rate g Y h i d Ascent rate.

Rate Descent rate [Off]

A descent speed exceeding the permitted value while below the set depth activates this alarm.

See descent rate setting in Setup Alarms → Rat Y F U h Y g Y Descent rate.

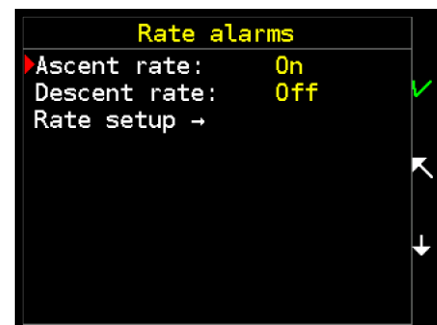
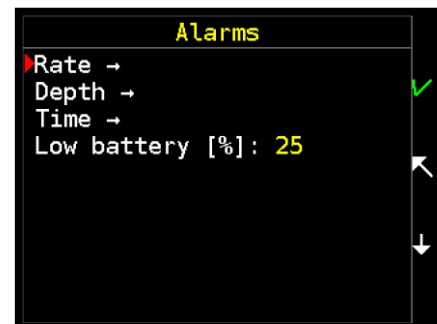

Rate setup - Ascent rate

Rate is used for the indication of the ascent rate, if relative measuring (percentage) is set in Setup

Preferences Vertical speed .

Speed 1 [10 m/min / 33 ft/min]

The anticipated ascent rate within small depths, in zone 1 (range: 1 - 20 m/min).

The value is m/min in metric and ft/min in imperial units.

Depth zone 1 [10 m / 3 ft]

The depth defining zone 1. This zone lies between the surface and the set depth (range: 0 - 300 m).

The value is m in metric and ft in imperial units.

Speed 2 [10 m/min / 33 ft/min]

The anticipated ascent rate within medium depths, in zone 2 (range: 1 - 20 m/min).

Depth zone 2 [80 m / 262 ft]

The depth defining zone 2. This zone lies between depth zone 1 and the set depth (range: 0 - 300 m).

Speed 3 [18 m/min / 59 ft/min]

The anticipated ascent rate within large depths, in zone 3. (range: 1 - 20 m/min).

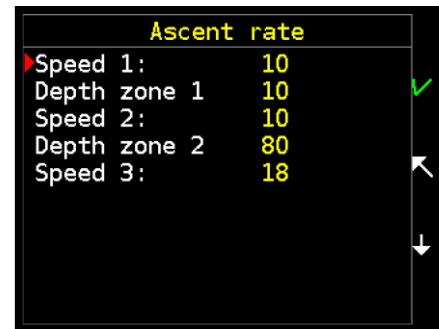

Rate setup - Descent rate

Rate is used for the indication of the descent rate, if relative measuring (percentage) is set in Setup

Vertical speed.

Warn under [80 m]

The threshold at which the alarm is activated to indicate exceeding the descent rate. At smaller depths, exceeding the descent rate is ignored.

The value is m in metric and ft in imperial units.

This alarm is disabled in factory default setting. It can be enabled in Setup

Alarms F.U.h.Y

Max rate [20 m/min]

The anticipated descent rate (range: 1 - 40 m/min).

The value is m/min in metric and ft/min in imperial units.

Max rate 30 m/min is used to indicate a descent rate at a depth shallower than the warn-under depth.

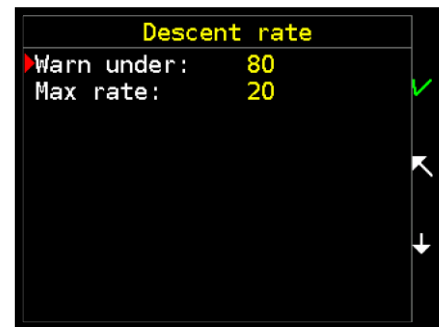

Depth

A notification that the set depth during a descent has been reached. It is possible to set three separate depths in the range of 0 - 300 m, where 0 means deactivation of the notification.

Time

A notification that the dive time has been reached. It is possible to set three separate times in the range of 0 - 999 min., where 0 means deactivation of the notification.

Low battery [25 %]

The alarm is activated if the remaining battery capacity falls below this limit.

Range is 0 - 40%; 0 means that the alarm is disabled.

If set to a value greater than 10 %, then a second alarm occurs when reaching 10 %.

6.1.4 Preferences

Screensaver [0 s]

The display will be switched off after the screensaver timeout expires. Zero disables this feature (i.e. display is on all the time).

Show by light [On]

The display can be activated (switched on) with a light beam. The light sensor is on the side of the display adjacent to the buttons, so the light beam has to come from the side opposite the buttons.

Move the Freedom to the light beam instead of moving the beam to prevent confusion with a light signal.

Screens

Any of the dive mode screens can be disabled.

Timeouts

Timeouts - Surface idle [10 min]

The Freedom will be switched off after this timeout expires (range: 1 - 120 min).

Before switching off, the Shutdown? [Yes/No] is displayed for 30 s. Select No to restart this timer and keep the Freedom on.

Timeouts - Prepared idle [15 min]

The manually activated dive mode will be switched back to surface mode if the dive does not start during this timeout (range: 1 - 120 min).

Timeouts - Dive termination [10 min]

The dive will be terminated after surfacing and if no subsequent submersion starts during this timeout (range: 0 - 30 min). Zero disables this feature (i.e. dive will not be terminated automatically).

Timeouts - Dive end Confirm [Off]

If the dive end confirmation is On then a confirmation dialog is displayed for 30 s before the dive ends. Select No to restart the dive termination timer and keep the Freedom in dive mode.

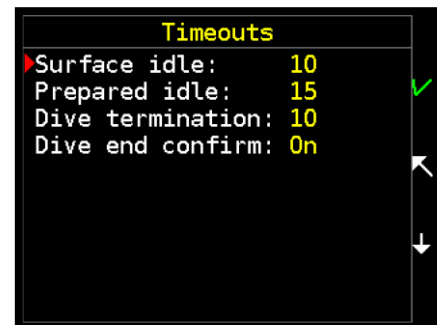
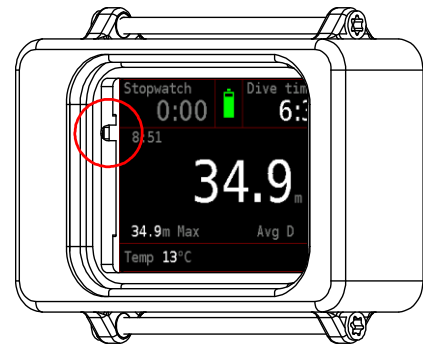
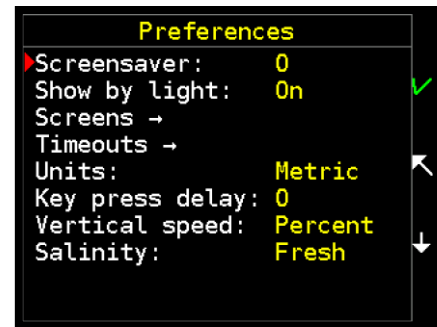

Units [Metric]

Imperial or metric units can be selected.

Key press delay [0]

If a greater value than 0 is set then a longer button press is needed to be recognized as valid user input. This can decrease button sensitivity and help avoid unintended activation. However, this will create a delay for all intended button presses.

Vertical speed [Percent]

If percent is set then the ascent and descent rate are indicated relatively to the ascent and descent speed limits. If unit/min is set then the ascent or descent rate are indicated in depth unit per minute.

Salinity [Fresh]

If changed to the Sea option then the density of seawater will be used for the depth calculation. The majority of depth gauges is calibrated to fresh water. Do not change this setting unless a direct comparison with a depth gauge calibrated to seawater is needed or decompression calculations based on seawater density is used.

6.1.5 Calibration

Note: For rebreather see [C g Y b g c f g \(page\) StartCh d calibration 29](#).

Horizontal calibration

Allows the calibration of accelerometers, which are used for control by tilt. Place the computer horizontally (display up) and press any key. It is preferred to use a stable horizontal surface (e.g. a table).

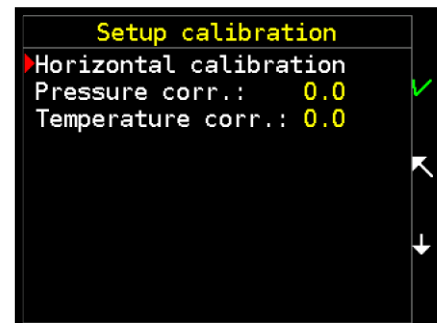

Pressure corr. [0.00 mbar]

Specify pressure sensor correction for a more precise measurement of barometric pressure or altitude. This correction is not needed for general use.

Temperature corr. [0 \$ " \$ ' ...7 # ...: Q

Specify temperature sensor correction for a more precise measurement of temperature. This correction is not needed for general use.

6.1.6 Date and time

Local time in format YYYY/MM/DD hh:mm:ss can be set.

It is advised to set the local time of a destination prior to leaving for a diving vacation in a different time zone.

Editor use

Tilt toward yourself decrease the entered digit by one

Tilt to the left move the cursor to the left

Tilt to the right move the cursor to the right

Press upper key discard editing (reset to previous value)

Press both keys exit without saving

Press lower key save and exit

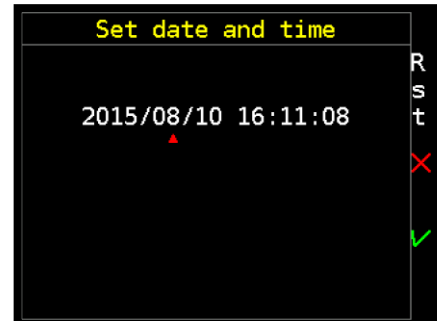

6.1.7 Factory defaults

Reset all settings to default values (except date and time).

Computer will be restarted and the horizontal calibration will start automatically after the reset.

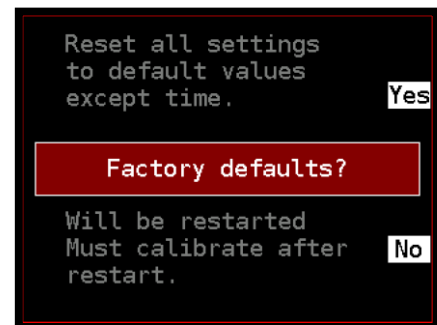

Section 7: Rebreather

The following functions are only available in the CCR Bottom Timer version.

7.1 Surface menu

The Rebreather menu item.

7.1.1 Stack time reset

Don't forget to reset the timer when you refill the scrubber.

See also [Stack warning \[0 min\]](#) (page 30).

7.1.2 Start C calibration

It is preferred to calibrate O₂ sensors prior to each dive. Do not use sensor readings from sensors calibrated more than three days ago.

Procedure:

1. Rebreather Start C calibration
2. Check the calibration gas
3. Wait for stable values
4. Start and wait for the process to end
5. Confirm the save

Whether or not a sensor is already at the end of its service life is also determined during calibration.

At higher altitudes above sea level, the partial pressure of oxygen in the calibration mixture decreases in proportion to lower atmospheric pressure. The Freedom measures atmospheric pressure and takes it into account during calibration. Therefore, do not perform any corrections at higher altitudes above sea level.

7.1.3 Change C cal.

If possible, use oxygen with purity of at least 99.5% for calibration.

Do not use air for calibration. The partial pressure of oxygen in air at atmospheric pressure significantly differs from the partial pressures determined by the

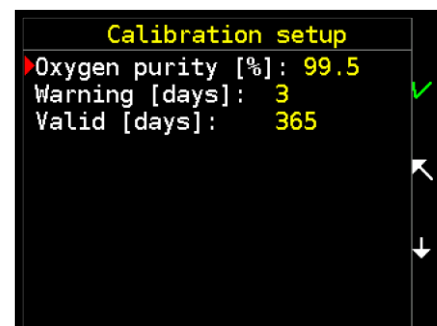
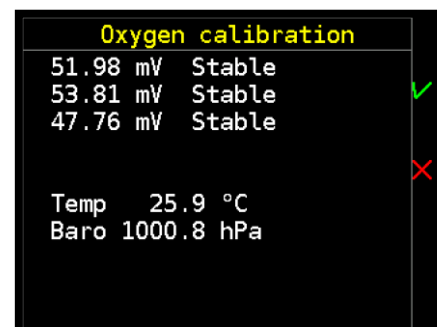
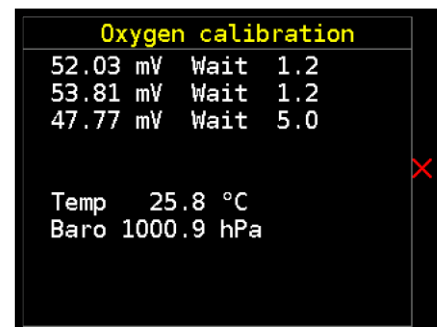
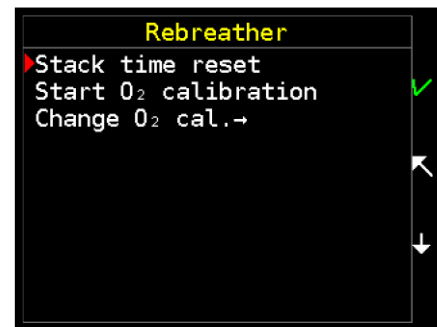

setpoints. At the end of its service life, an oxygen sensor can successfully undergo

WU`] V f U h] c b` h c` &%i` fl U] f Ł ž` V i h` k] ` ` ` b c` ` c b [Y fher.V Y` WU d U V

7.2 Setup

Stack warning [0 min]

Set the scrubber lifetime. The stack time warning will be generated a fter this time expires . Zero disables this feature.

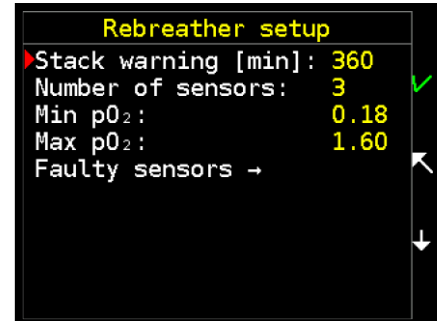

Number of sensors [0]

9 b h Y f` h \ Y` b i a V Y f` c Z` C` W \ Y a] WU` ` g Y b g c f g` Wc One, Y Wh Y X` h c` two or three sensors can be connected.

The cable equipped with the Molex connectors is included in the Closed Circuit version of the Divesoft Freedom distribution package or can be ordered separately.

A] b` d C` ` O \$ " % , ` V U f Q

H \ Y` ` c k` d C` ` U` U f] a Z`] hg \ Y W W i] fj f U h b X` d C` `] g` (range 0.18 \ U b` h \ Y` g 0.40 bar).

A U I` d C` ` O % " * \$ ` V U f Q

H \ Y` \] [\` d C` ` U` U f a`] g` U Wh] j U h Y X`] Z` W (range: 0.18 h` d C` `] g` V] [1.6 bar).

Faulty sensors

You can mark any connected but untrustworthy sensor as disabled. By doing so, you will remove these sensors from the calculation of the average d C` ` "

Section 8: System check

8.1.1 Version

The version license is fixed to hardware serial number and not transferable to another unit. The serial number is needed for the firmware upgrade.

Check www.divesoft.cz/support for new firmware versions.

When reporting a bug, please indicate the FW version including the build number.

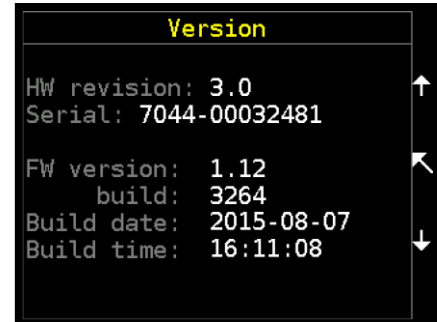

8.1.2 License

This screen describes the scope of the SW license. Mixture specification is only applicable for the Divesoft Freedom in decompression computer versions.

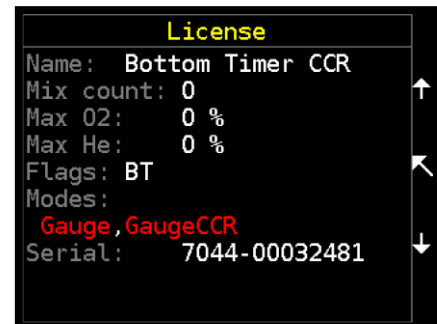

8.1.3 Battery

Detailed state of the battery is described.

The battery voltage (Ubat) is measured precisely. The remaining battery power and estimated runtime is determined by the voltage.

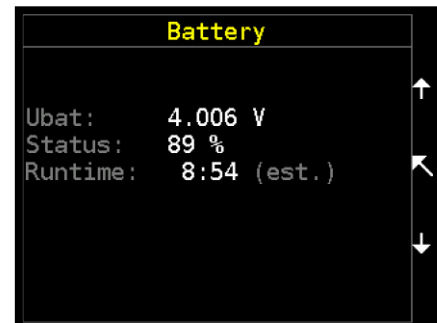

8.1.4 Pressure sensors status

The atmospheric pressure depends on the altitude and weather. Average sea-level pressure is 1013.25 m bar.

The current altitude is calculated from the atmospheric pressure. It is merely an approximate value, deviation up to 200 m is not a malfunction and does not require correction.

The sensor correction for a more precise measurement of barometric pressure or altitude and temperature can be set in Setup Calibration.

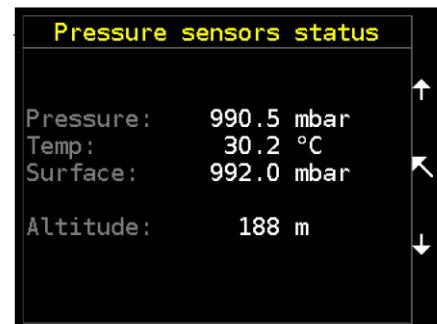

Section 9: Games

Do not disable alarms if the games are played during a deco stop.

Ensure to not accidentally reposition yourself while playing during a dive. Check the pressure gauge on a regular basis. Playing a game will reduce your attention. Remember: you want to decompress safely, not just achieve a higher level in the game!

The games were tested on children. Nobody was hurt.

9.1 Sokoban

Sokoban is a type of transport puzzle, in which the player (a diving mask with snorkel) pushes tanks or crates around in a warehouse, trying to get them to storage locations (red dots).

The game is played on a board of squares, where each square is either a floor or a wall. Some floor squares contain tanks, and some floor squares are marked as storage locations.

The player is confined to the board, and may move horizontally or vertically onto empty squares (never through walls or boxes). The player can also move into a tank, which pushes it into the square beyond. Tanks may not be pushed into other tanks or walls, and they cannot be pulled. The puzzle is solved when all tanks are in the storage locations.

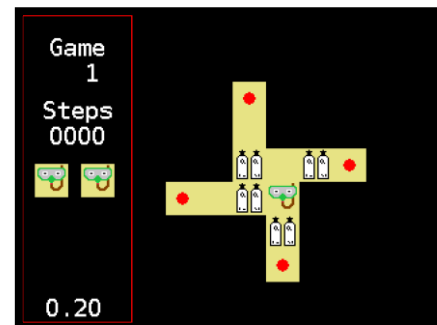

9.2 Snake

Snake is a game where the player maneuvers a line which grows in length, with the line itself being a primary obstacle.

The player controls the head of the snake. As it moves forward, it leaves a trail behind, resembling a moving snake. The snake has a specific length. The player loses when the snake runs into the screen border, a trail or another obstacle, or eats poison (skull), or starves to death.

The snake loses its length slowly (every 30 steps), and when it is too short, it dies from starvation.

The player attempts to eat fish by running into them with the head of the snake. Each fish eaten makes the snake longer, so maneuvering becomes progressively more difficult.

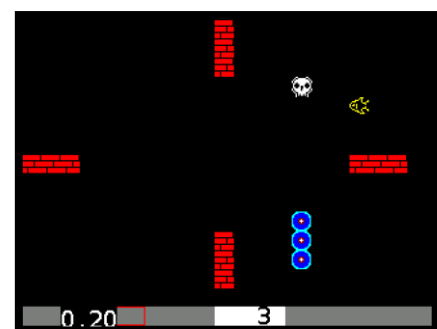

Section 10: Service functions

Service functions are primarily intended to support a qualified technician or to be performed with the recommendation of the manufacturer's technical support.

These functions are not blocked but no end user support is provided. A detailed description is beyond the scope of this manual. An IT specialist can understand most of them without further description.

The service functions menu is accessible via the coded key press (press both keys; release one key and press it again; release both keys).

10.1.1 Debug

All debug information is read only. There is no risk associated with browsing them just for curiosity.

Sensors

A detailed state of all sensors.

Deco model

This has no use in the bottom timer version of the Divesoft Freedom .

Scheduler

The firmware task list with information specifying the system footprint.

Variables

The values of some internal variables.

10.1.2 Test

There is no risk associated with performing these tests just for curiosity while on the surface.

Buttons

It runs a simple test of both buttons.

Vibration

It runs a short test of the vibration.

Display

A red, green and blue screen will be displayed for the display test.

Watchdog

Watchdog is a timer that is used to detect and recover from firmware malfunctions. You can intentionally hang the computer via the Freeze system function and test a recovery; computer automatically restarts if watchdog works properly.

Warning: Do not test system freezing during a dive !

Test dive

The test dive is used by the manufacturer or an authorized service for the pressure sensor calibration and tightness test. It is similar to the gauge mode. The test dive log will be stored, but clearly marked as a test dive. The test dive is not included in the log summary.

10.1.3 Demo dive

The demo dives are suitable for those interested in a demonstration of the Divesoft Freedom features. There is no risk associated with performing the demo dive.

During a demo dive almost all functions can be tested on the surface. One exception is the pressure sensor reading. Also, O g Y b g c f g ` Wc b b Y Wh Y X ` k] h \ ` U ` WU V ` Y ` WU b

The Emergence du Ressel demo dive uses the authentic depth profile from the penetration through the first sump of this French cave.

Demo dive logs can be permanently stored into the log memory. The oldest dive logs will be replaced by the new demo dive log if the memory is full. Demo dive logs are clearly marked.

A demo dive log, if this is the last dive, can be erased later using Demo dive Erase demo log.

10.1.4 Syslog

The system events log list. All information is read only.

10.1.5 Miscellaneous

Warning: These functions can alter values of internal variables or/and the state of the Divesoft Freedom. Use them with caution and only if you understand the consequences.

Force Dive Start

It can be used for an extraordinary shallow dive in a place where initial submersion to a depth greater than 1.5 m is impossible. This can also be used if the automatic dive start failed for any reason (e.g. submersion recognition algorithm is confused by previous pressure changes unrelated to diving).

Force Dive End

= Z \ h \ Y \ g i f Z U W Y \ d f Y g g i f Y \ f l n Y f c \ X Y d h \ k U g \] b W c f f Y W h \ m \ while on the surface then the dive can be forced to stop with this function.

Browse config

Every setting can be read and changed. The majority of settings can also be changed using an ordinary setup; the equivalent minimum and maximum limits for every setting will be applied. There are only few internal configuration parameters intended for special use.

Reset deco data

This has no use in the bottom timer version of the Divesoft Freedom.

Bootloader

Restart to the bootloader mode for the firmware update or version upgrade.

Connect the USB cable included in the distribution package to the USB port of your computer where the DSLoader software is properly installed. See www.divesoft.cz/support for further information and for the firmware download.

Section 11: Hardware

11.1 Charging

Use the USB charger included in the distribution package or any USB port suitable for charging. The included charger is international; it can be connected to the all major wall sockets.

Remove the protective film from the back of the computer by the lid, then unscrew the connector lid before attaching the cable.

The computer may or may not be switched on during charging. If the computer is switched on, then the icon in the top-right corner on the surface screen indicates the state of charge.



Charging in progress



Battery is full, but plugged into the charger

It takes about 5 hours to charge from near empty state to fully charged.

Maximum charging current is less than 500 mA, so there is no difference between charging using the charger or charging from an ordinary computer USB port.

Charge the battery at least once every six months.

11.2 Wrist mount

If you prefer a strap, pass the strap under the bars. Use the Velcro on the strap to tighten.

If you prefer a bungee, then remove the screws holding the bars using a Torx screwdriver.

If you want to use a silicon protective sleeve, install it before installing the bungee. It is not possible to put the sleeve on the computer with the bungee already installed.

Pass the bungee through the threaded holes and secure with a knot. There is a special thread inside the holes which does not damage the bungee.

Use a small flame to melt the braid of the bungee and make a tip on the end of it for easier pass-through.

Both the strap and bungee are included.

In any case, the opening on the back of the computer must remain freely accessible. When you mount the computer directly on bare skin avoid closing the opening. The pressure sensor is located there.

11.3 Physical dimensions

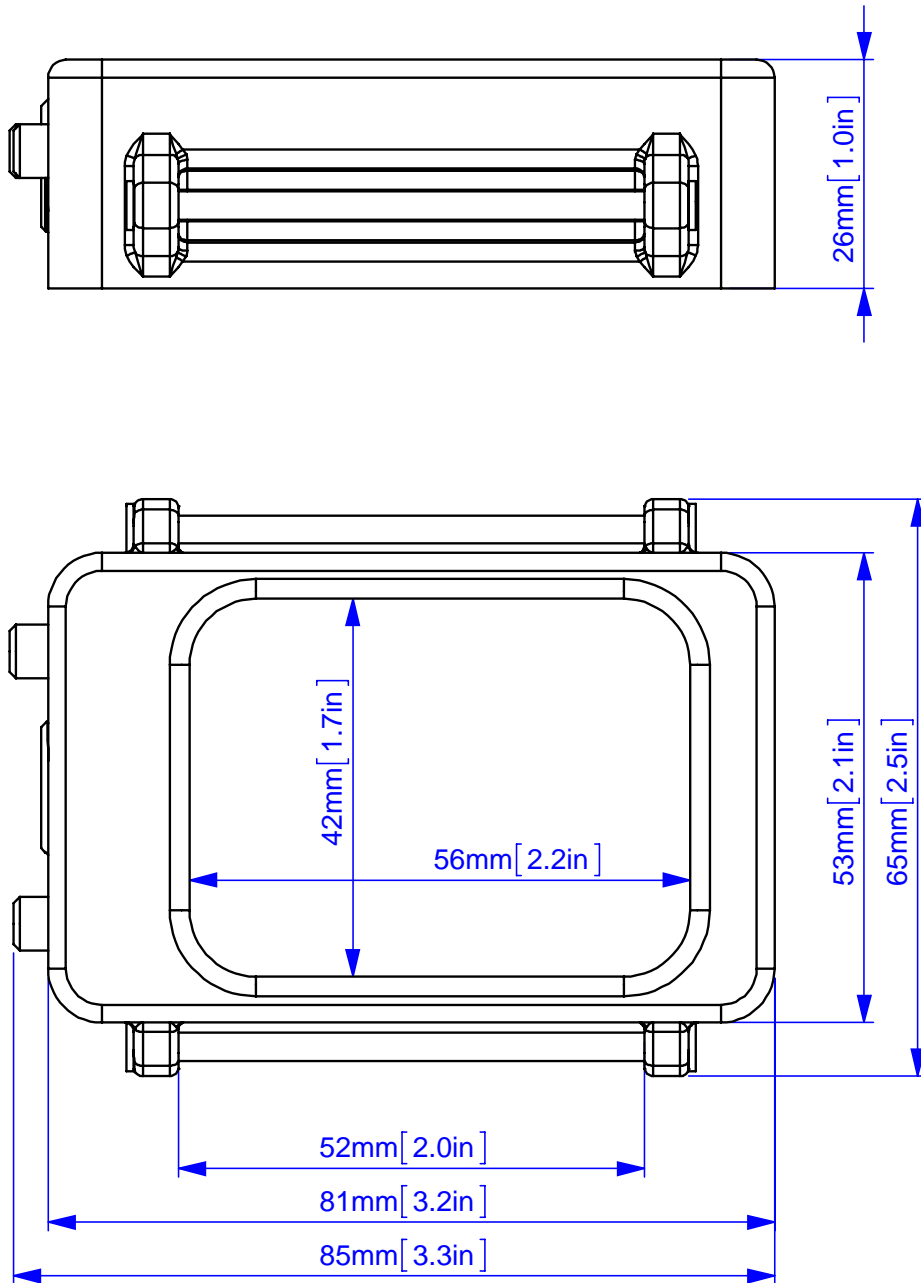

11.4 C sensor cable

The cable equipped with the Molex connectors is included in the Closed Circuit version of the Divesoft Freedom distribution package or can be ordered separately.

The technical design of the connections on a specific type of rebreather is not covered in this user manual .

